

Specifications

Electrical Characteristics	Nominal Voltage	12.8V
	Rated Capacity	75AH
	Series X Parallel Maximum	4S X 4P
	Circuit Protection	Over charge, Over discharge, Over current, Over temp, Short, Balance
	Cycle Life	>2000 cycles at 0.2C 100% DOD
	Monthly Self Discharge	Less than 2%
	Efficiency of Charge	100% @ 0.5C (when used with proper LiFePO ₄ charger)
	Efficiency of Discharge	96 ~ 99% @ 1C
Charge	Charge Voltage	14.4 ± 0.2V
	Standard Charge Current	15A
	Max. Charge Current	75A
Discharge	Std. Discharge Current	15A
	Max. Continuous Current	80A
	Discharge Cut-off Voltage	~9V
Environmental	Charge Temperature	0°C to 55°C (32°F to 131°F) at 60 ± 25% Relative Humidity
	Discharge Temperature	-20°C to 60°C (-4°F to 140°F) at 60 ± 25% Relative Humidity
	Storage Temperature	-20°C to 45°C (-4°F to 113°F) at 60 ± 25% Relative Humidity
Mechanical	Cell Material	LiFePO ₄
	Case / IP Class	Plastic / IP65
	Dimensions (in / mm)	10.24 x 6.69 x 8.19 (8.19 HT) / 260 x 170 x 208 (208 HT)
	Approx. Weight (lbs /kg)	18.96/ 8.6
	Terminal Type	M8
Optional	Extended Functions	Power Switch, SOC indicator, USB, Communications (CANBUS, Bluetooth, SMBUS, RS485, RS232, UART, I ² C)

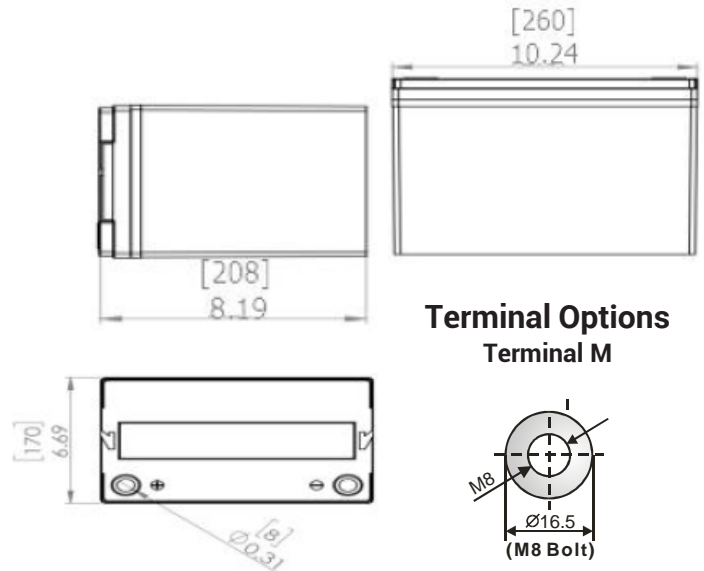

Physical Dimensions



Discharge Characteristics

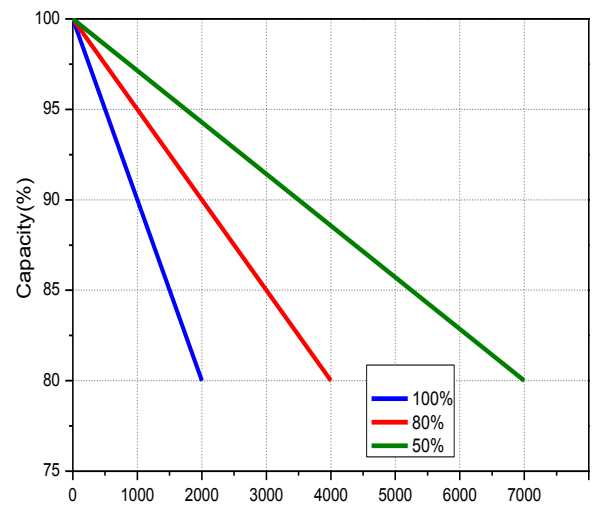

* Use ZEUS matching PCCG-LFP14.4V10A LiFePO₄ or PCCG-LFP14.4V15A LiFePO₄ charger to achieve optimum performance

**Modular design enables deployment of up to four batteries in series and up to four batteries in parallel.